



# Alfa Delta METAMORF

## User's Manual

Version 1.2, August 11, 2025.  
Alfa Delta © 2025  
<https://alfadelta.be/metamorf.html>

Welcome	3
Features	4
In the box	5
Installing	5
Functional overview	6
One of 6 filters overview	8
Controls and connections	10
Output selection	12
Parameter and value selection	12
Definitions	12
VCF1 - VCF6	13
Long press 1 : Presets	18
Long Press 2 : Copy parameters	18
Long Press 3 : MIDI program change channel	18
Long Press 4 : Offset calibration CV inputs	19
Long Press 6 : Update	19
Bias and 4-quadrant modulator	20
Quantiser setting the base note	20
Mix1, Mix2	21
Notes (Steps)	22
MIDI	23
Overview of factory presets	26
Usage tips, patching	27
Startup	27
	1

Explore VCF parameters and settings	27
Explore VCF outputs	27
Explore Mixers	28
Explore inputs and external modulations	28
Explore internal modulations	28
Factory presets update	29
Firmware update	30

# Welcome

Congratulations with your purchase of METAMOPΦ (Metamorf), an analog voltage and MIDI controlled multiple digital filter/delay and mixer, with an analog look and feel and digital precision, accuracy and tuning and tracking stability.

METAMOPΦ can be used as a VCF, or rather 6 of them, as up to 6 delays, as up to 6 bias modulea, as up to 6 4-quadrant modulators, as a mixer, well two of them, and as any combination of modules, and that is just scratching the surface.

METAMOPΦ has an extensive modulation matrix which can use any CV input or VCF or Mixer or MIDI as a source and route it to all possible modulations, like Exponential FM, thru-zero Linear FM, QM (resonance), 4-quadrant AM and Ping. Each modulation source has a depth (from -1 to +1) parameter and a depth control source with a min. and max. depth (from -1 to +1) parameter.

By assigning modulation depths to CV inputs and using the Bias pots, one has immediate control over any modulation. Minimum and maximum modulation depth can be set separately from -1 to +1, allowing e.g. 2 (or more) parameters in the same or different VCFs to be controlled in reverse from 1 Bias pot. MIDI controllers can be used for the same purpose, and at the same time all CV inputs remain available.

Frequency can be controlled by the master Cutoff pot, FM and 1V/ oct. inputs with a choice of quantisers. Frequency of individual filters can be set in ratios or in fixed steps (1 cent resolution). On top of that, there are 2 detune modes : in cents and FineHz.

Cross-modulation and exact frequency ratios and detune allow for precise multiple filter patches.

All settings can be stored in user presets, and there is a bunch of great factory presets as well to get you started.

The user interface features a graphical OLED display, 3 encoder dials and 6 pushbuttons for fast access to all parameters in all modules, without the need for menu diving.

METAMOPΦ is a versatile and complex module, so please read this manual for getting the most out of your module.

METAMOPΦ is designed and manufactured in Belgium.

Electronics and firmware design by Wim Verheyen.

Conceptual consultancy and early testing for usability by Boris Uytterhaegen.

# Features

- Eurorack 28 HP, 35mm depth.
- Digital module with analog ins and outs, analog look and feel.
- Values are indicated in musical units like steps, cents, Hz, seconds.
- Analog controlled 2-pole digital state-variable filter x 6. One output per filter.
- Two mix outputs. Six assignable inputs per mixer, can be VCF outputs or CV inputs.
- Frequency follows first filter with (quantised) detune and Fine Hz or independent frequency control or frequency ratio per filter.
- 1V/oct, 10 octaves range, perfect tracking and stability.
- Classic responses (LP, BP, HP, BR (notch), PK (peak), ALL), selectable per filter,.
- Delay function (200 ms max.) (up to 6, can be combined with filters), with the modulation matrix delay, phasing and flanging, mix with input signal input and feedback are possible.
- Voltage or MIDI Controlled Exponential FM, Linear FM (thru-zero), QM and AM per filter.
- Exponential FM, Tru-zero Linear FM, QM and AM depth control from CV inputs or VCF outputs.
- All modulations from zero to full depth from DC to 20 kHz.
- 6 freely assignable CV modulation inputs with initial and depth control (no analog attenuverters, digital attenuverters) and peak detect indicator on display, can also be used as signal inputs.
- 2 freely assignable signal inputs, with depth control and peak indicator on display, can also be used as CV inputs.
- 6 freely assignable gate inputs for pinging (positive edge, negative edge, both edges).
- Cross modulation of each parameter of each filter.
- Quantizer with different scales (Equal, Just, Pythagoras aug4, Pythagoras dim5, Mean tone, Harmonic, Werckmeister, Arabic).
- 16 bit resolution on all inputs and outputs, sample rate is 100 kHz.
- Easy parameter navigation : 4-line 21-character graphic OLED display, 3 encoder dials, 6 buttons, no menus.
- Useful factory presets.
- 2 banks of 64 user presets.
- MIDI input for free firmware and preset updates and MIDI notes (note number (ST) 60 is middle C (C4)), pitch bend, velocity, after touch, continuous controllers (7 and 14 bit) and preset selection (bank and program change).
- MIDI controller “learn” mode immediately assigns a MIDI controller to a parameter.
- Extensive manual, which is needed for a complex module like this.
- Handy Patch sheets in Pages and Word format.
- Power requirements : +12 V 170 mA, -12 V 75 mA.

## In the box

- The METAMOPΦ module.
- 16-to-10-pin Eurorack power cable.
- Mounting hardware: four M3 x 6 mm phillips head screws, four nylon washers.
- Alfa Delta sticker and business card.

## Installing

The module features a shrouded header and MOSFET protection against polarity reversal.

The module is intended to be mounted in a Eurorack compatible rack.

Make sure the power to your case is disconnected before installing the module.

Ensure that the power supply of your case can supply sufficient power for all your modules, including METAMOPΦ.

It is strongly advised to use a decent power supply and busboards with shrouded headers.

Plug the 10-pin connector of the power cable into the module.

Plug the 16-pin connector of the power cable into the bus board of your case.

If your bus board does not feature shrouded headers, replace it by a decent bus board, or if you insist, make sure the red stripe on the power cable aligns with the -12V pins on the board.

Double-check that both connectors are correctly oriented and fully inserted.

Mount the module in the front of the case with the supplied screws and nylon washers.

Now power up the case, if all is well you will see a welcome message on the display for 3 seconds after which the module displays its output, parameter and value.

If you don't observe this proper behaviour, switch off the power immediately and check your connections and power supply.

# Functional overview

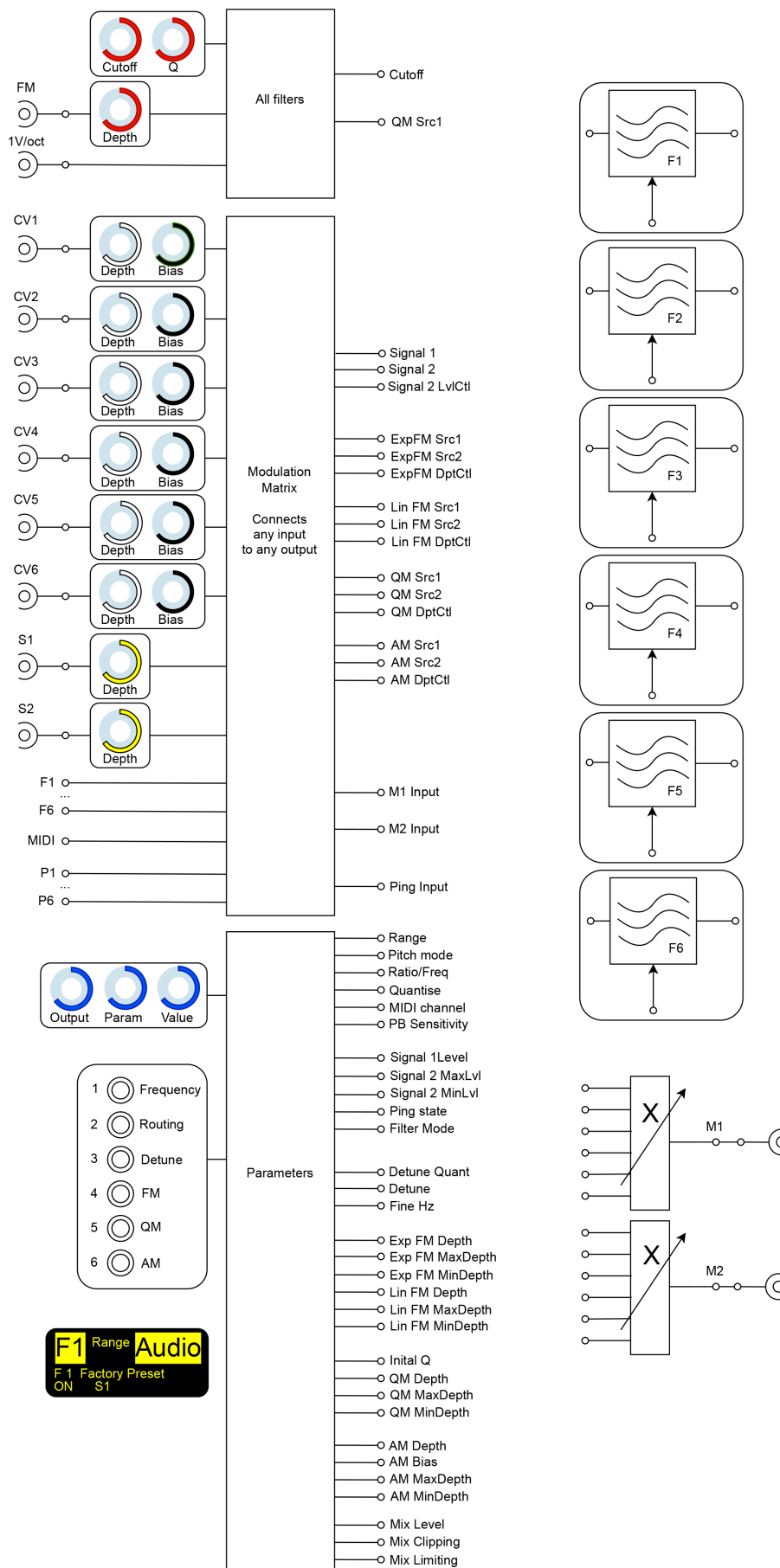

## All filters

On the top left is the All filters block which controls all filters, it features Cutoff and Q pots, a FM input with attenuator and a calibrated 1V/octave input.

## Modulation matrix

Below that is the modulation matrix

On the input side are 6 CV inputs with attenuator (depth) and bias pots, and 2 signal inputs with attenuator (depth) pots, the outputs of all filters and mixers and the MIDI input. Also on the input side are 6 digital inputs.

On the output side are all modulation and depth control sources to the filters. The outputs are shown here for 1 filter, in reality there are 6 groups of outputs, 1 for each filter. Also on the output side are the mixer inputs (6 per mixer) and the Ping input (per VCF).

Any input can be routed to any output in any combination.

## Parameters

On the bottom left is the Parameters block.

It is controlled by 3 encoder dials and 6 pushbuttons for easy selection of the different parameters, shown on the OLED display.

The parameters are shown here for 1 filter, in reality there are 6 groups of parameters, 1 for each filter.

The parameters are shown here for 1 mixer, in reality there are 2 groups of parameters, 1 for each mixer.

## Filters

To the right are the six filters which are viewed in depth on the next page.

## Mixers

And below that are the 2 6-input mixers. Any input of the mixer can select any CV input or any filter output, together with the mix level.

# One of 6 filters overview

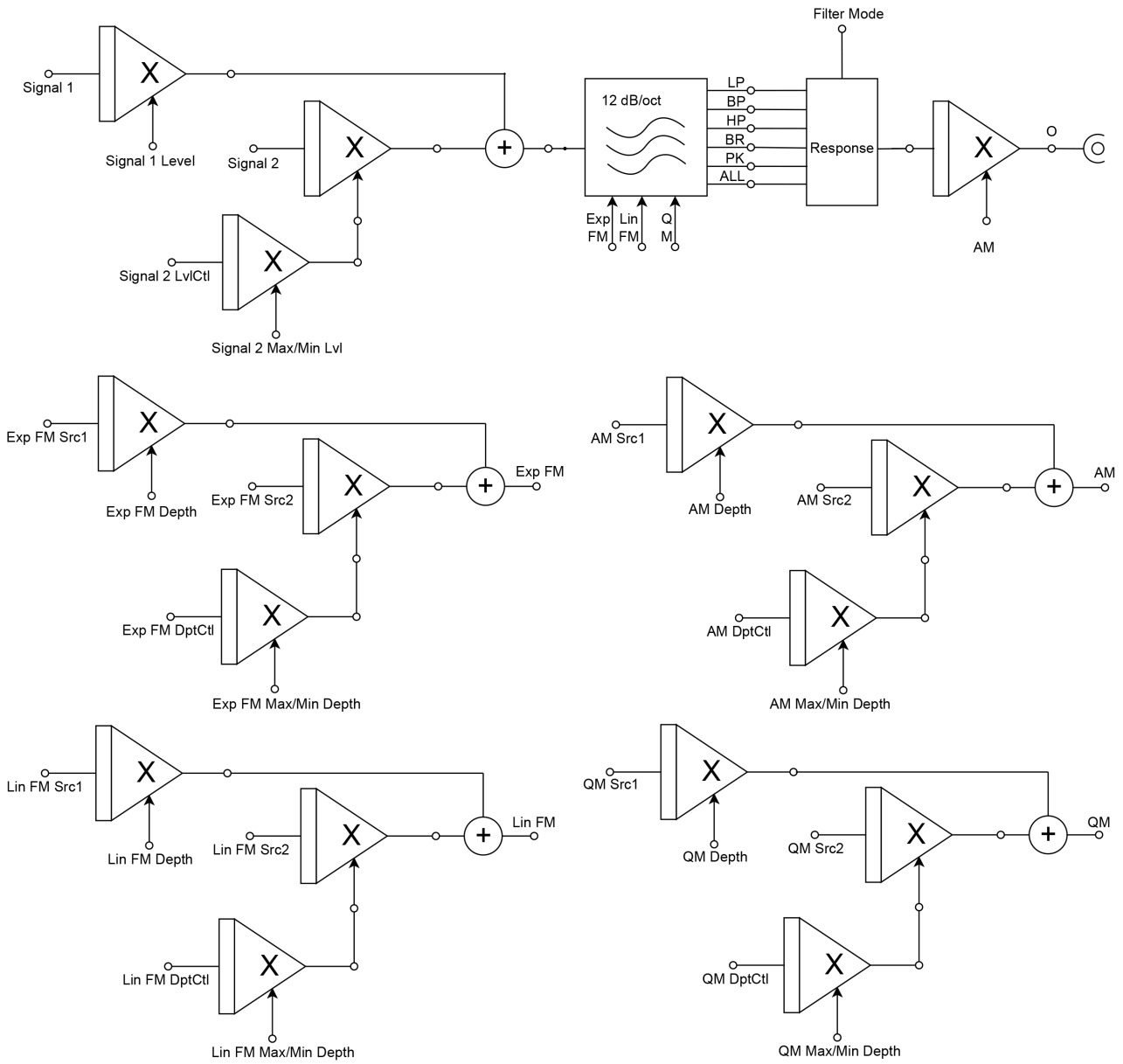

Each filter has 2 signal inputs.

Each filter has 4 analog control inputs : Exponential FM, Linear FM, QM and AM, and 1 digital control input : Ping.

Each of the analog signal and control inputs is preceded by 3 4-quadrant multipliers, enabling selection of the modulation inputs, selection of the depth control source, and setting of the modulation and control depth (max. and min.), according to the parameters shown on the previous diagram.

Filter response, pitch mode, quantisation, ping, MIDI channel, Pitch Bend range and detune are additional parameters per filter.

Each filter has 1 signal output.

# Controls and connections

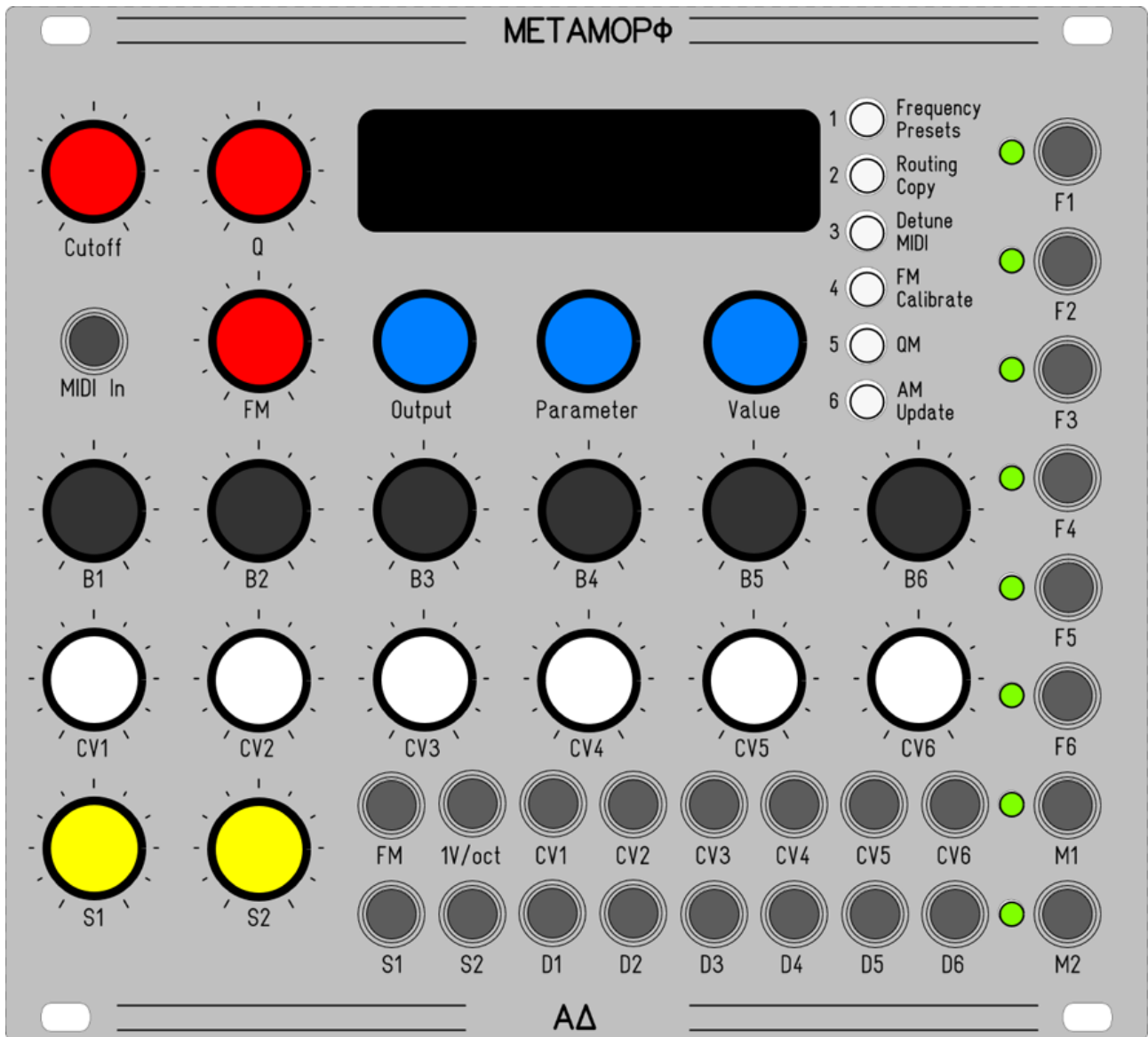

## Controls

- **Cutoff** frequency pot, range 11 octaves.
- **Q** / delay pot, range from 0 to 1.
- Exponential **FM** unipolar level control, labeled FM.
- **Output** dial for module selection (F1 to F6, M1, M2).
- **Parameter** dial for parameter selection, parameter range is dependent on the selected module.
- **Value** dial for value selection, value range is dependent on the selected parameter.
- 6 filter parameter page selection buttons. In Mixer mode these select the input channel. In preset mode these function as bank select buttons.
- 32 by 128 pixel graphical OLED display.
- 6 bias controls (black), labeled B1 to B6, add a bias from 0 V to 5 V to CV1 - CV6 inputs.
- 6 modulation **depth** controls (white), labeled CV1 to CV6, unipolar attenuators for inputs CV1 - CV6.
- 2 signal **depth** controls (yellow), labeled S1 to S2, unipolar attenuators for inputs S1 - S2.

## Outputs

- 6 filter outputs, labeled F1 to F6, nominal output voltage from -5 V to +5 V, max. output voltage from -6 V to +6 V, with bipolar LED indication.
- 2 mixer outputs, labeled M1 and M2, max. output voltage from -6 V to +6 V, with bipolar LED indication.

## Inputs

- 6 CV input jacks, labeled CV1 to CV8, range DC to 20 kHz, -5 V to +5 V.
- 2 signal input jacks, labeled S1 to S2, range DC to 20 kHz, -5 V to +5 V.
- Exponential **FM** input, labeled FM.
- **1V/oct** calibrated input, labeled 1V/oct.
- 6 digital inputs, accepting any signal from DC to 20 kHz, labeled D1 to D6.
- MIDI TRS (Type A, MIDI standard) input, labeled MIDI in.

## Display

- The top line at the left shows the selected module (F1 to F6, M1, M2).
- The top lines in the middle shows the selected parameter.
- The top line at the right shows the selected value.
- The third line at the left shows the selected preset : bank and number.
- The third line at the right shows the selected preset name.
- The bottom line at the left indicates incoming MIDI messages (ON, OFF, PB, CC, SOX, EOX or ... if the MIDI channel does not match the MIDI source).
- The bottom line at the right indicates a peak value on the input(s) (1S, 2S, 1C - 6C).

# Output selection

The **Output dial** selects : VCF1 (F1) to VCF6 (F6), Mix1 (M1), Mix2 (M2).

- Pushing the Output dial for more than one second resets the output selection to VCF1.

# Parameter and value selection

The **Parameter dial** selects from a list of parameters, dependent on the selected page, output or module.

- Pushing the Parameter dial for more than one second resets the parameter to the first one applicable for the selected page, output or module.

The **Value dial** selects from a list of values, dependent on the selected parameter.

- Pushing the Value dial for more than one second resets the value to the first one applicable for the selected parameter.
- Pushing the **Value dial** for less than a second moves from +-100, +-10 or +- 1 increments (where applicable), indicated by the cursor in the display. Pushing the **Parameter dial** for less than a second moves from +-1, +-10 or +- 100 increments (where applicable), indicated by the cursor in the display. Selecting another parameter resets the increment to a default, applicable for the parameter..

# Definitions

## Modulation Source list

Off, S1, S2, CV1, CV2, CV3, CV4, CV5, CV6, VCF 1, VCF 2, VCF 3, VCF 4, VCF 5, VCF 6, MIX 1, MIX 2, Q, Note, PitchB., Veloc., Ater T., LearnCC, LCC no., MCC no.

## Signal input list

Off, S1, S2, CV1, CV2, CV3, CV4, CV5, CV6, VCF 1, VCF 2, VCF 3, VCF 4, VCF 5, VCF 6, MIX 1, MIX 2

## Sync input list

Off, D1, D2, D3, D4, D5, D6, VCF 1, VCF 2, VCF 3, VCF 4, VCF 5, VCF 6.

## Master frequency

The frequency as set by **Cutoff, FM and 1V/oct** in Ratio Mode with Ratio = 1.

## ST

SemiTone, 1/12 th of an octave.

## ct

cent, 1/100 th of a semitone or 1/1200 th of an octave.

# VCF1 - VCF6

Page pushbuttons and their parameters.

## 1. Frequency page

- Pitch Mode : Ratio, Fixed. Default is Ratio 1x.
  - In Ratio Mode :
    - Ratio : 0.1000 to 64.000 in 0.005 steps, x relative to the master frequency
  - In Fixed Mode :
    - Frequency : 0.00 (8.18 Hz) -135.00 ST (19912.12 Hz). in 0.01 steps (1 cents). 69.00 is A4 (440 Hz, tuning reference). ST is corresponding to MIDI note number.
- Quantise : Off, Equal, Just, Pythagoras aug4, Pythagoras dim5, Mean tone, Harmonic, Werckmeister, Arabic. Default is Off. See setting the base note in the next paragraph.
- MIDI channel : Off, 1 - 16. The Filter specific MIDI channel. Default is Off.
- PitchBend Range : 0 - 60 ST in 1 steps. Default is 0 ST (no Pitch Bend).

## 2. Routing page

- Signal 1 input : select from Signal input list. Default is S1.
- Signal 1 level : from -100 (inverts signal) to +100. Default is 100.
- Signal 2 input : select from Signal input list. Default is S1.
- Signal 2 Level Control Off/Source : Signal 2 depth control source, select from Modulation Source list. Default is Off.
- Signal 2 Max Depth : max. level depth from -1.000 to + 1.000 in 0.001 steps. Default is +1.000.
- Signal 2 Min Depth : min. level depth from -1.000 to + 1.000 in 0.001 steps. Default is +1.000.
- Input Limit : MAX (limits the input so clipping never occurs), MIN (clipping may occur), OFF (no input limiting, best for use with Ping input). Default is MAX.
- Ping input : Ping input list. Default is Off.
- Ping state : Positive edge, Negative edge, Both edges. Default is Positive.
- Filter State : Off, LP, BP, HP, BR, PK, ALL, DELAY, On. Default is LP.
- In DELAY state, frequency and Q settings are ignored.

## 3. Detune page

- Detune Quantise : Off, Equal, Just, Pythagoras aug4, Pythagoras dim5, Mean tone, Harmonic, Werckmeister, Arabic. Default is Off.
- Detune amount (exponential detune, just like on an analog VCO). Detunes up to 2 octaves up or down in steps of 1 cent. Default is 0 cents, max. is + or - 2400 cents.
- Fine Hz (constant beatings over the whole frequency range) amount in steps of 0.1 Hz. Default is 0.0 Hz, max. is + or - 100.0 Hz.

#### 4. FM page

- Exp FM Off/Source 1 : select from Modulation Source list. Default is Off.
- Exp FM Depth 1 : modulation depth from -1.000 to + 1.000 in 0.001 steps. Default is +1.000.
- Exp FM Off/Source 2 : select from Modulation Source list. Default is Off.
- Exp FM Depth Control 2 Off/Source : Exp FM depth control source, select from Modulation Source list. Default is Off.
- Exp FM Max Depth 2 : max. modulation depth from -1.000 to + 1.000 in 0.001 steps. Default is +1.000.
- Exp FM Min Depth 2 : min. modulation depth from -1.000 to + 1.000 in 0.001 steps. Default is +1.000.
- Lin FM Off/Source 1 : select from Modulation Source list. Default is Off.
- Lin FM Depth 1 : modulation depth from -1.000 to + 1.000 in 0.001 steps. Default is +1.000.
- Lin FM Off/Source 2 : select from Modulation Source list. Default is Off.
- Lin FM Depth Control 2 Off/Source : Lin FM depth control source, select from Modulation Source list. Default is Off.
- Lin FM Max Depth 2 : max. modulation depth from -1.000 to + 1.000 in 0.001 steps. Default is +1.000.
- Lin FM Min Depth 2 : min. modulation depth from -1.000 to + 1.000 in 0.001 steps. Default is +1.000.

#### 5. QM/delay page

- Initial Q/delay : Q from 0 to + 1000 in 1 steps, default is 60. Delay from 0.0 to 200.0 ms in 0.1 ms steps, default is 0.0.
- QM/delay Off/Source 1 : select from Modulation Source list. Default is Q for filters, Off for delay.
- QM/delay Depth 1 : modulation depth from -1.000 to + 1.000 in 0.001 steps. Default is +1.000.
- QM/delay Off/Source 2 : select from Modulation Source list. Default is Off.
- QM/delay Depth Control 2 Off/Source : QM depth control source, select from Modulation Source list. Default is Off.
- QM/delay Max Depth 2 : max. modulation depth from -1.000 to + 1.000 in 0.001 steps. Default is +1.000.
- QM/delay Min Depth 2 : min. modulation depth from -1.000 to + 1.000 in 0.001 steps. Default is +1.000.

#### 6. AM page

- AM Off/Source 1 : select from Modulation Source list. Default is Off, which sets the VCF level to from -5 V to + 5 V.
- AM Depth 1 : modulation depth from -1.000 to + 1.000 in 0.001 steps. Default is +1.000.
- AM Bias : bias from -1.000 to + 1.000 in 0.001 steps. Default is +1.000.
- AM Off/Source 2 : select from Modulation Source list. Default is Off, which sets the VCF level to from -5 V to + 5 V.
- AM Depth Control 2 Off/Source : AM depth control source, select from Modulation Source list. Default is Off.
- AM Max Depth 2 : max. modulation depth from -1.000 to + 1.000 in 0.001 steps. Default is +1.000.
- AM Min Depth 2 : min. modulation depth from -1.000 to + 1.000 in 0.001 steps. Default is +1.000.

The following scope shots illustrate the effect of the Max Depth en Min Depth setting with an AM example.

The left side of the diagram corresponds to the bias pot (or whatever depth control source chosen) at minimum, the right side of the diagram corresponds to the bias pot at maximum. The rising line (ramp) corresponds to the position of the bias pot.

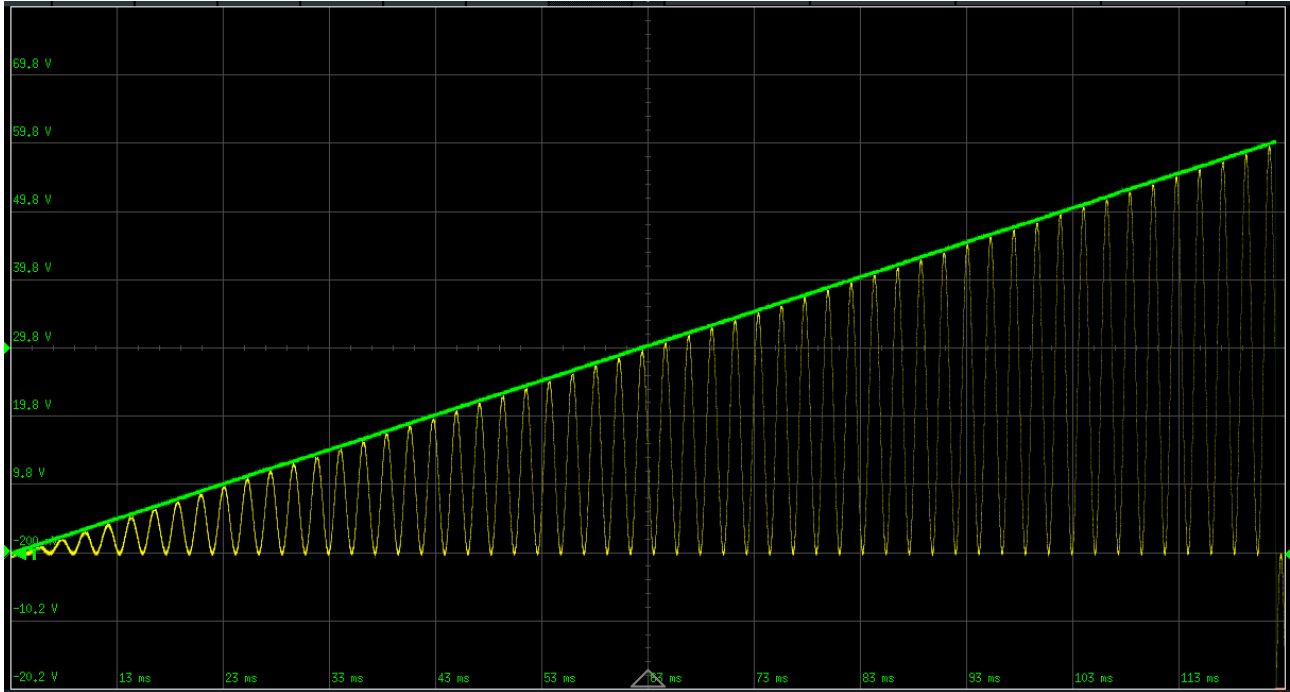

AM Max Depth = 1.000, Min Depth = 0.000

With the bias pot at minimum there is no AM, with the bias pot at maximum, there is max. AM.

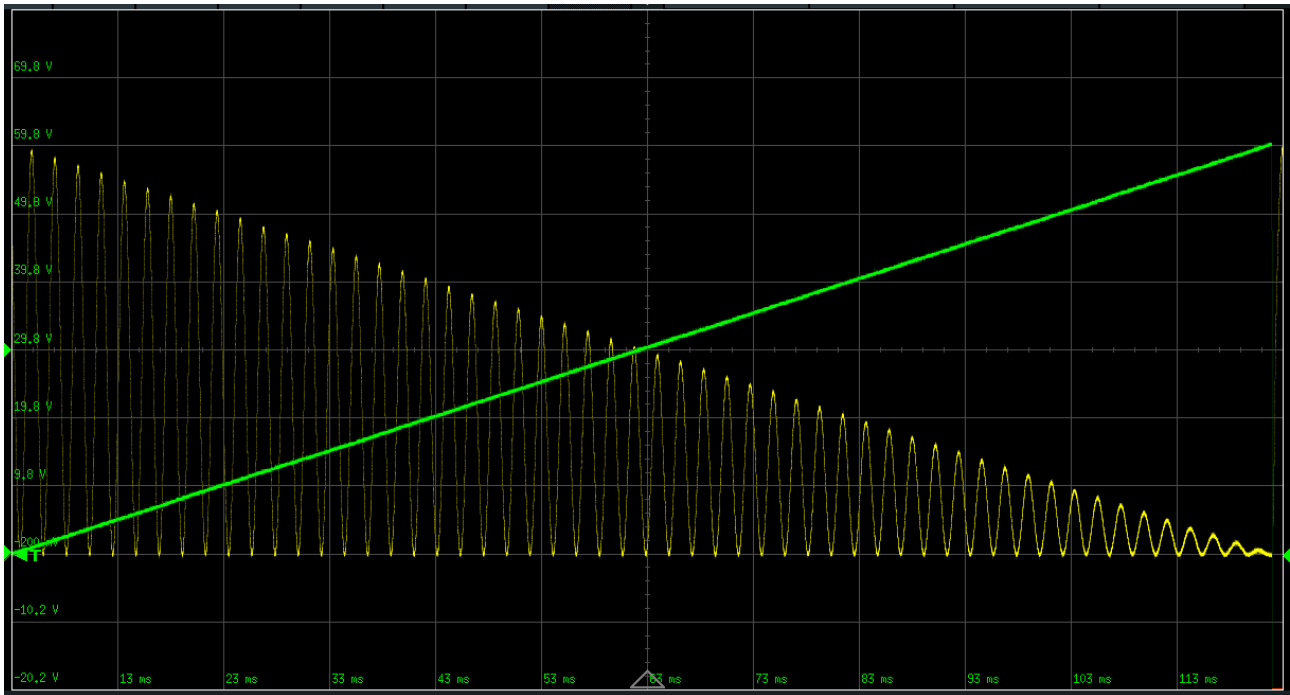

AM Max Depth = 0.000, Min Depth = 1.000

With the bias pot at minimum there is max. AM, with the bias pot at maximum, there is no AM. So this has the effect of reversing the action of the bias pot (or the CV input).

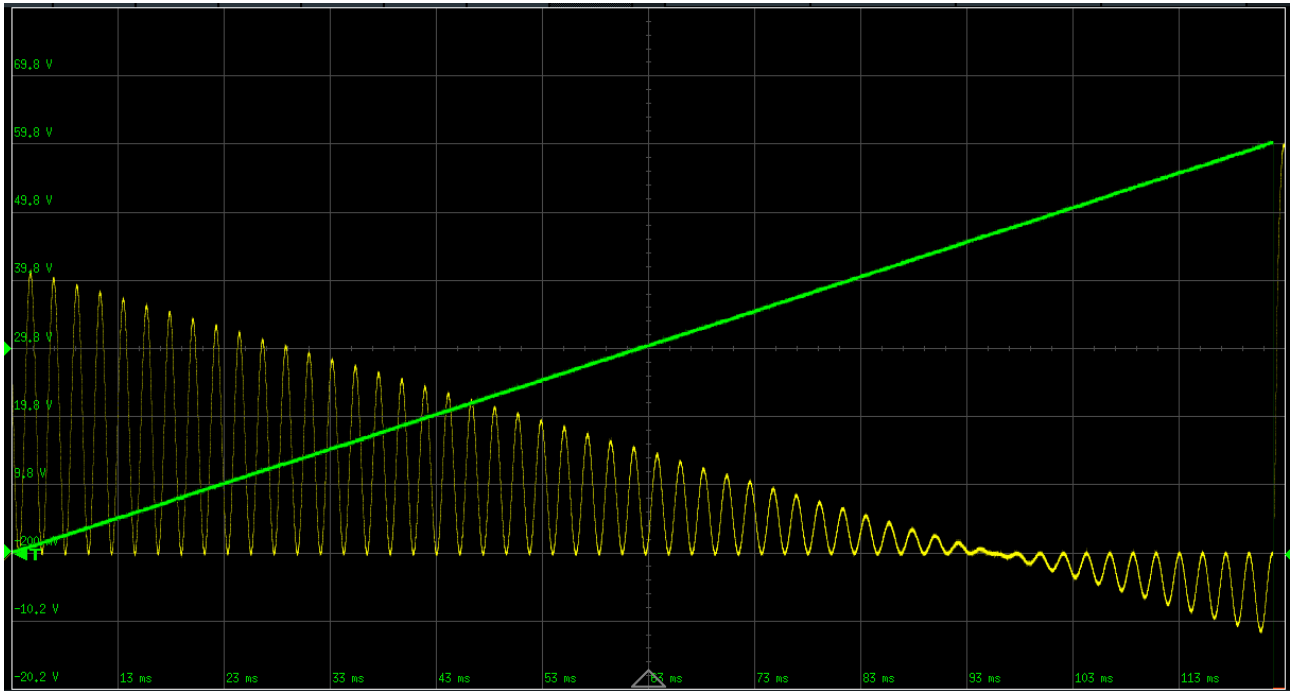

AM Max Depth = -0.200, Min Depth = 0.700  
 Any combination of Max and Min, positive or negative is possible.

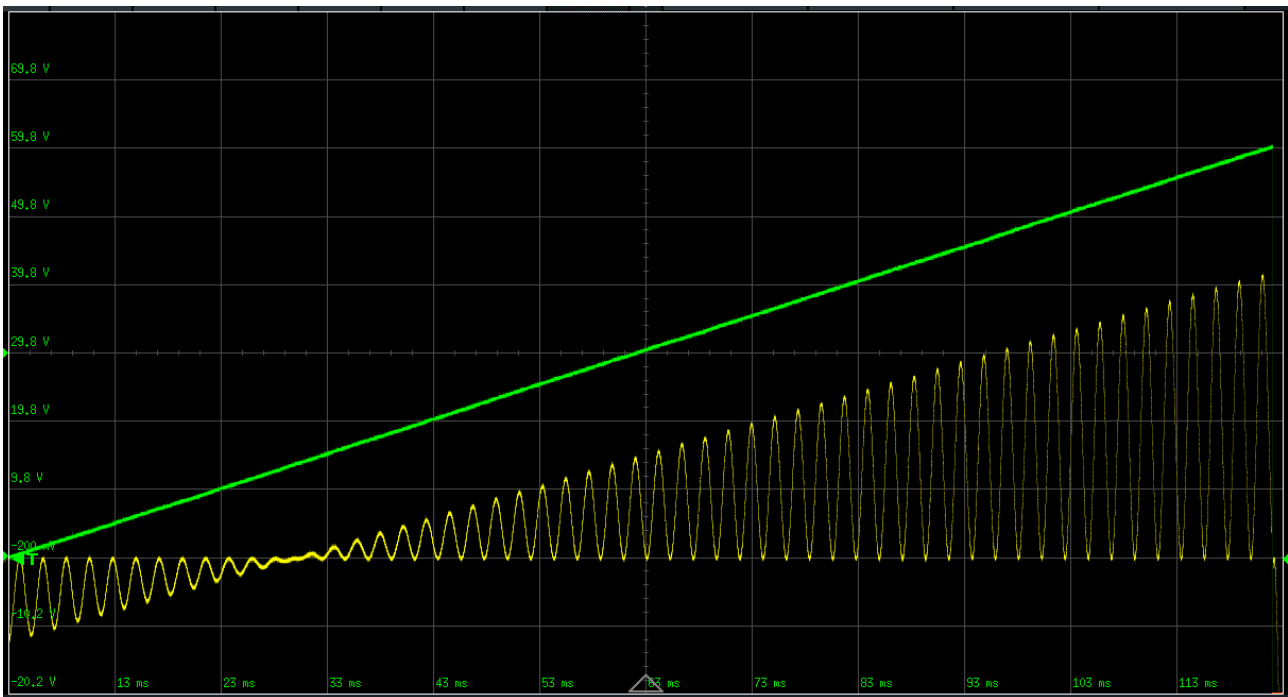

AM Max Depth = 0.700, Min Depth = -0.200

And the same as the previous one with Bias of 0.100 added.

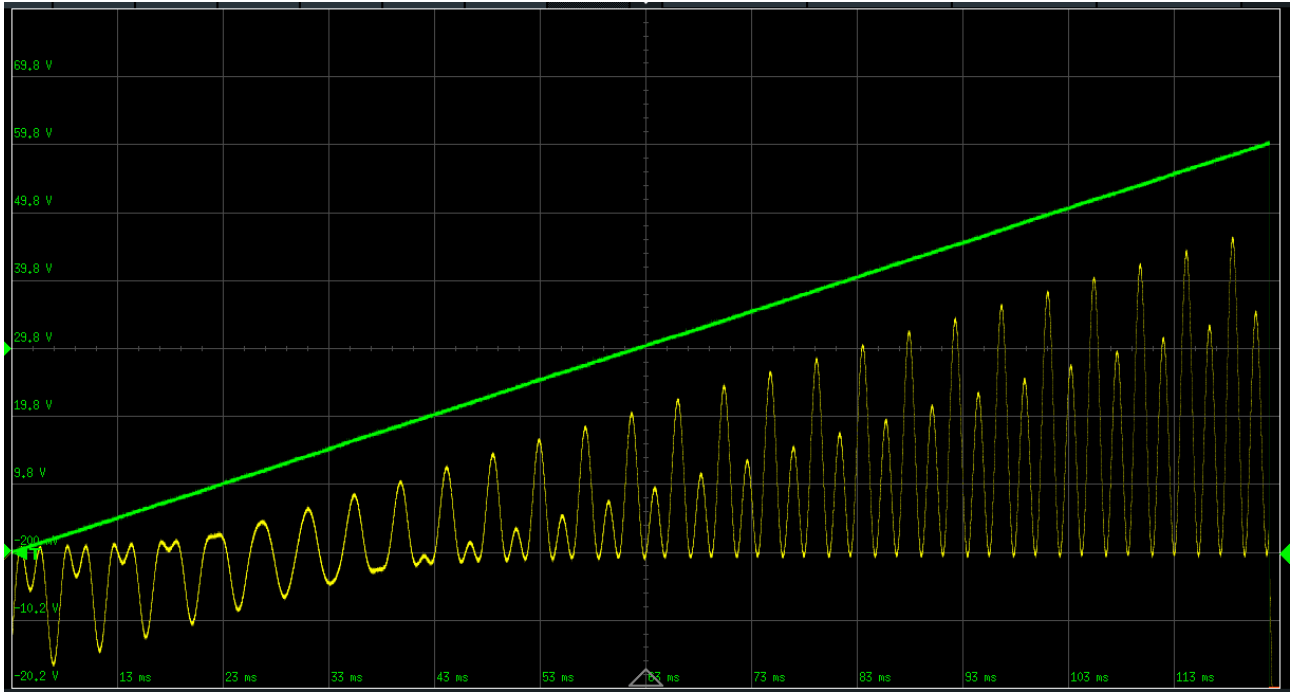

## Long press 1 : Presets

Load and save settings in presets.

By a long press on the “1” button, the presets function is activated.

Pushbutton 1 selects user bank 1 (U1), pushbutton 2 selects user bank 2 (U2), pushbutton 3 selects factory presets (F), factory presets cannot be saved.

The **Value** dial selects a preset number in a bank (1 - 64).

### Load :

- Long press the **Parameter** dial to load.
- If found : load proceeds and the display changes to “Loaded”.
- If not found : display shows “Not found”.

### Save :

- Long press the **Parameter** dial.
- If nothing is saved in the selected preset : proceed to naming the preset.
- If the selected preset is already occupied : display shows “Overwrite” “No”. If you really want to overwrite this preset, turn the **Parameter** dial to “Yes”. Long press the **Parameter** dial.
- Display shows “Name ? “. Name the preset : the **Parameter** dial selects the cursor position, the **Value** dial changes the character above the cursor, the Buttons select part of the complete character set.
- Initially and after each cursor move, the selection is the complete character set, limit this by pushing Button 1 ... 4.
- Button 1 selection ! “ # \$ % & ‘ ( ) \* + , - . /
- Button 2 selection number 0...9 : ; < = > ? @
- Button 3 selection upper case characters A...Z [ \ ] ^ ‘
- Button 4 selection lower case characters a...z { | } ~
- Long press the **Parameter** dial, save proceeds and the display changes to “Saved”.

To exit Load or Save (with or without loading or saving), turn the **Parameter** dial.

## Long Press 2 : Copy parameters

By a long press on the “2” button in a VCF module, the copy function is activated.  
There are 3 choices.

Copy Param : this copies the current parameter to the same parameter in all VCF's.

Copy Page : select a destination VCF, this copies the current parameter page of the current VCF to the same parameter page of the destination VCF.

Copy Module : select a destination VCF, this copies all parameters of the current VCF to the destination VCF.

To exit the copy function there are 2 choices :

A long press on the “2” button will do the copy action.

A short press on the “2” button will go back to normal operation without copying.

A short press on the “1” button will go back to normal operation without copying.

## Long Press 3 : MIDI program change channel

By a long press on the “3” button, the MIDI program change channel function is activated.

MIDI Channel for Program change and bank select can be selected (1 - 16, default is 1) with the **Value** Dial.

To exit this function short press on the “3” button.

## **Long Press 4 : Offset calibration CV inputs**

The CV inputs are factory calibrated for zero offset, so normally there is no need to calibrate again.

**Important** : make sure all bias and CV pots are at their minimum and no external CV is applied.

By a long press on the “4” button, the calibration function is activated.  
A long press on the “4” button will calibrate all the CV inputs.

To exit the calibration function short press on the “4” button.

## **Long Press 6 : Update**

By a long press on the “6” button, the Update function is activated.

A long press on the “6” button will reboot into the updates.  
A short press on the “6” button will go back to normal operation without updating.

## **Bias and 4-quadrant modulator**

By setting a VCF response to On, it can be used as a standalone bias module or a 4-quadrant modulator.

By changing the AM bias parameter, the output can be set to any value between -5 V and + 5 V.

By setting the AM bias parameter to 0, setting the AM input to one of the CV's, setting the AM index input to another CV, the output will be the 4-quadrant product of both CV inputs, hence a 4-quadrant modulator for external signals.

So if you have 1 or more spare VCF's in the module, it can be used as either bias or 4-quadrant modulator.

## **Quantiser setting the base note**

The Base note is C (middle C (C4) is 60 ST).

To get to the base note, set VCF1 to Equal and VCF2 to Pythagoras. Turn the **Cutoff** frequency pot until both VCF's are at the exact same frequency (zero beatings).

The base note can be changed by setting a detune value in whole steps.

Fine tuning can be done with the detune parameters.

## Mix1, Mix2

Pushbuttons select Input channel / Level 1 to 6.

- Input : select from Input list, Off disables the input. Default for input channel 1 of both mixers is VCF1. Other input channels default to Off.
- Level : from -100 (inverts signal) to +100. Default for input channel 1 of both mixers is 100. Other input channels default to 0.

The following parameters appear for each input channel for convenience, they are applicable to all input channels.

- Clipping : Hard, Soft. Default is Hard.
- Limiting : Off (Takes the sum of all enabled input signals, will cause clipping if levels are set too high), Max. (Takes the sum of all enabled input signals x 1.5 divided by the number of enabled inputs, may cause clipping if signals are in phase, but gives stronger output), Min. (Takes the sum of all enabled input signals divided by the number of enabled inputs, will never cause clipping, even if all levels are at - or +255, but gives weaker output). Default is Min.

## Notes (Steps)

Set a filter to Pitch mode Fixed.

Note number (ST) 60 is middle C (C4).

Note number (ST) 69 is A4, 440 Hz, which can be used as tuning reference.

Note numbers correspond to MIDI note numbers.

Here is an overview of all note values in the 4th octave :

C	60
C#	61
D	62
D#	63
E	64
F	65
F#	66
G	67
G#	68
A	69 (440 Hz)
A#	70
B	71

To obtain note value (ST) in other octaves, add or subtract a multiple of 12 to the above values.

# MIDI

## Sysex

Sysex for presets and firmware updates is implemented, see further in this manual.

## Program change

Program change 1 - 64 and bank select (LSB) 0 (U1), 1 (U2), 2 (F) loads the preset if available. MIDI Channel for Program change and bank select can be selected (1 - 16, default is 1) with the [Value Dial](#).

## Notes and pitch bend

Note on events and Pitch Bend are specific for each VCF, according to the specific MIDI channel for the VCF.

If the ratio of a second VCF has to follow the frequency of a first VCF that is set to MIDI, set the second VCF to the same MIDI channel as the first VCF.

Note number 60 (middle C, C4) does not affect the set (as with [Cutoff](#)) VCF frequency, higher note numbers will increase, lower note numbers will decrease the set frequency.

Setting the quantiser to anything but Off or Equal will use a different scale for the MIDI notes.

Note number, Pitch Bend, Velocity, After Touch and C(ontinuous)C(ontrollers) can be selected as (index) Inputs.

## Continuous controllers

The easiest way to assign a CC is to set the input value to LearnCC. Then move any controller and it will have immediate effect on the selected input. The controller number is saved. Then set the input value to LCC (Learned CC), the number after LCC is the learned CC. Do not leave the input value to LearnCC because any other controller that changes will overwrite the LCC value.

It is also possible to select any other CC from the MCC (Manual CC) list : MCC1 - MCC31 (MSB, CC 33 - 63 are the LSB), MCC 64 - MCC 119.

Please note that CC 33 - 63 cannot be used, because MIDI defines them as the LSB counterparts of CC 1 - 31. There are controllers (e.g. fader banks) that implement CC 33 - 63 as if it were MSB controllers, this is not according to the MIDI specification and if possible they should be set to proper CC numbers.

Metamorf has a 14 bit MIDI CC implementation that uses CC 1 - 31 as MSB and CC 33 - 63 as LSB.

It will also correctly respond to 7 bit MIDI CC messages, with a lower resolution of course.

## **NRPN**

Be careful not to use CC6, as this is used by the NRPN messages.

NRPN allows you to change parameters from a MIDI device. This works by incrementing/decrementing the parameter value, not by setting an absolute value. By doing so, it works exactly like the value change on the module itself. The display on the module will indicate the module/parameter/value.

It works by sending the following messages (H stands for hexadecimal format) :

BxH Control change, x is the MIDI channel  
63H NRPN MSB  
nn Parameter number MSB, VCF1 is 0, VCF2 is 1, etc, Mix1 is 6, Mix2 is 7  
BxH  
62H NRPN LSB  
mm Parameter number LSB, see below  
BxH  
06H Data entry MSB  
pp NRPN data value : 1 is increment, 0 is decrement

The following parameters (mm as mentioned above) can be changed by MIDI NRPN messages :

0 Pitch mode  
1 Ratio/Frequency  
2 Quantise  
MIDI channel cannot be changed from MIDI obviously  
4 PitchBend Range  
  
5 Signal 1 input  
6 Signal 1 level  
7 Signal 2 input  
8 Signal 2 Level Control Off/Source  
9 Signal 2 Max Depth  
10 Signal 2 Min Depth  
11 Input Limit  
12 Ping input  
13 Ping state  
14 Filter State  
  
15 Detune Quantise  
16 Detune amount  
17 FineHz  
  
18 Exp FM Off/Source 1  
19 Exp FM Depth 1  
20 Exp FM Off/Source 2  
21 Exp FM Depth Control 2 Off/Source  
22 Exp FM Max Depth 2  
23 Exp FM Min Depth 2  
  
24 Lin FM Off/Source 1  
25 Lin FM Depth 1  
26 Lin FM Off/Source 1  
27 Lin FM Depth Control 2 Off/Source  
28 Lin FM Max Depth 2  
29 Lin FM Min Depth 2  
  
30 Initial Q  
31 QM Off/Source 1  
32 QM Depth 1  
33 QM Off/Source 2

34 QM Depth Control 2 Off/Source  
35 QM Max Depth 2  
36 QM Min Depth 2  
  
37 AM Off/Source 1  
38 AM Depth 1  
39 AM Bias  
40 AM Off/Source 2  
41 AM Depth Control 2 Off/Source  
42 AM Max Depth 2  
43 AM Min Depth 2  
  
50 Mix Input 1  
51 Mix level 1  
52 Mix Clip  
53 Mix Limit  
54 Mix Input 2  
55 Mix level 2  
58 Mix Input 3  
59 Mix level 3  
62 Mix Input 4  
63 Mix level 4  
66 Mix Input 5  
67 Mix level 5  
70 Mix Input 6  
71 Mix level 6  
  
99 Inc/Dec : moves the cursor left/right

# Overview of factory presets

See the preset sheets for a detailed description.

# Usage tips, patching

## Startup

All VCF's are in Ratio mode, ratio 1x, Sine wave, MIDI, Pitch Bend, Quantise and Detune Off, Phase at 0 degrees, all modulations Off, output level from -5 V to +5 V, Sync from D1 on positive edge. Parameter page selected is Filter, parameter selected is Pitch Mode.

Mixer 1 has VCF1 on input 1 full strength, hard clipping, limit Off. Parameter selected is Input1.

Mixer 2 has VCF1 on input 1 full strength, hard clipping, limit Off. Parameter selected is Input1.

## Explore VCF parameters and settings

Connect Mix1 and Mix2 outputs to your output module.

Turn the **Cutoff** knob to get a feel of the frequency range.

Change the response of VCF1.

Select Input2 on Mix1 and set it to VCF2, set Level2 to 100.

Set Limit to Min.

You will now hear an equal mix of VCF1 and VCF2 on Mix1 output.

Select Input2 on Mix1 and set it to Off.

Select Input1 on Mix2 and set it to VCF2.

You will now hear VCF1 on Mix1 output and VCF2 on Mix2 output.

Change the Ratio of VCF2 to 2x, 3x etc. Also try fine Ratio.

Turn the **Cutoff** knob and observe the VCFs keep their ratio.

Change the mode of VCF2 to Fixed, set the step parameter, then turn the **Cutoff** knob, observe VCF1 changing frequency and VCF2 not.

## Explore VCF outputs

Patch the individual outputs to your output module.

Use separate outputs for different waveforms. See preset 14.

Use separate outputs for different phases. See presets 15 and 16.

Use separate outputs for chords. See presets 11 and 12.

## Explore Mixers

The mix of VCFs can be controlled from AM, Set the AM input of the VCFs to CV, and use the Bx pots or MIDI to control the levels, and/or apply CV to the CVx inputs for VC mixing.

A mix of CVs can be controlled in the same way.

## Explore inputs and external modulations

Apply **FM** to all VCF's (patched from another module, e.g. a VCO, LFO or envelope) and turn the **FM** pot up.

Apply **1V/oct** from a keyboard or a MIDI interface or use the MIDI input.

Apply RM to VCF1 (Select RM input CV1 patched from another module, e.g. a VCO, LFO or envelope) and turn the CV1 pot up.

Set RM Idx of VCF1 to CV2, patch output from another module, set CV1 pot to 10 and turn B2 pot up for modulation depth and/or CV2 pot for index modulation.

Exponential FM, PM and AM can be controlled in the same way.

## Explore internal modulations

Apply Linear FM to VCF1 from VCF2 (Select Lin FM input VCF2).

Set Lin FM DptCtl of VCF1 to CV2, turn B2 pot up to control the modulation depth. You can also use a MIDI controller as the Lin FM Idx to control the modulation depth.

Change VCF2 Ratio, next set VCF2 to Fixed mode and change VCF2 ST.

Exponential FM, PM and AM can be controlled in the same way. See presets 7, 9 and 10.

# Factory presets update

## Preparation :

- Download the latest presets file `fmpresets_x_y.zip` file from the website to your computer.
- Unzip the file, resulting in a `fmpresets_x_y.syx` file and a `release_notes.pdf` file.
- Read the release notes.
- Connect a MIDI cable from your MIDI interface to the MIDI TRS (Type A, MIDI standard) input.
- On a Mac, use SysEx Librarian app (<https://www.snoize.com/SysExLibrarian/>), load the `fmpresets_x_y.syx` file.
- On Windows, use MIDI SysEx Transfer Utility (<https://apps.microsoft.com/detail/9pfd4ddwgktn?hl=en-us&gl=US>).

## Update :

- Press the 6 button for more than 1 second. It will display : “U, Update Pre/Firm”.
- Press the 6 button again for more than 1 second : this will reboot the module into the updater. It will display : “U, Update Presets, Idle”.
- Select Update Presets with the **Parameter** dial.
- Pressing the **Parameter** dial for more than one second will first erase the old presets (this takes a few seconds) and then display “Sysex?”
- The module is now waiting for a sysex transfer.
- Start the transfer in SysEx Librarian.
- The display will start scrolling while the transfer proceeds, this takes max. 1 minute.
- When the transfer is complete, the display will show “Success”.
- Now turn the **Parameter** dial to “Restart Module” and press it for more than one second.
- Metamorf will now restart with the new presets.

## Possible errors :

- SID E! Wrong sysex identifier received (must be \$7D).
- DID E! Wrong device identifier received (must be \$01).
- FID E! Wrong format identifier received (must be \$02).
- CHK E! Checksum does not match.
- ER E! Flash memory not properly erased.
- VER E! Error in verification of flash vs. transferred file.

Please press the **Parameter** dial for more than one second if any of these occur to retry the update.

# Firmware update

## Preparation :

- Download the latest firmware file metamorf\_x\_y.zip file from the website to your computer.
- Unzip the file, resulting in a metamorf\_x\_y.syx file and a release\_notes.pdf file.
- Read the release notes.
- Connect a MIDI cable from your MIDI interface to the MIDI TRS (Type A, MIDI standard) input.
- On a Mac, use SysEx Librarian app (<https://www.snoize.com/SysExLibrarian/>), load the metamorf\_x\_y.syx file.
- On Windows, use MIDI SysEx Transfer Utility (<https://apps.microsoft.com/detail/9pfd4ddwgktn?hl=en-us&gl=US>).

## Update :

- Press the 6 button for more than 1 second. It will display : “U, Update Pre/Firm”.
- Press the 6 button again for more than 1 second : this will reboot the module into the updater. It will display : “U, Update Presets, Idle”.
- Select Update Firmware with the **Parameter** dial.
- **Warning !** You have a last chance here to leave the updater without changes : turn the **Parameter** dial to “Restart dionisi” and press it for more than one second. Dionisi will now reboot with the current firmware.
- Pressing the **Parameter** dial for more than one second will first erase the old firmware (this takes a few seconds) and then display “Sysex?”
- The module is now waiting for a sysex transfer.
- Start the transfer in SysEx Librarian.
- The display will start scrolling while the transfer proceeds, this takes about 2 minutes.
- When the transfer is complete, the display will show “Success”.
- Now turn the **Parameter** dial to “Restart Module” and press it for more than one second.
- Metamorf will now reboot with the new firmware.

## Possible errors :

- SID E! Wrong sysex identifier received (must be \$7D).
- DID E! Wrong device identifier received (must be \$01).
- FID E! Wrong format identifier received (must be \$01).
- CHK E! Checksum does not match.
- ER E! Flash memory not properly erased.
- VER E! Error in verification of flash vs. transferred file.

Please press the **Parameter** dial for more than one second if any of these occur to retry the update.